

GP25/GP25A Reader Quick Start

How to Use GP25/GP25A with Your Computer

1. Power requirements

12 Volts regulated DC @ 65mA typical. A linear regulator is needed.

2. Connect GP25/GP25A with computer via RS232

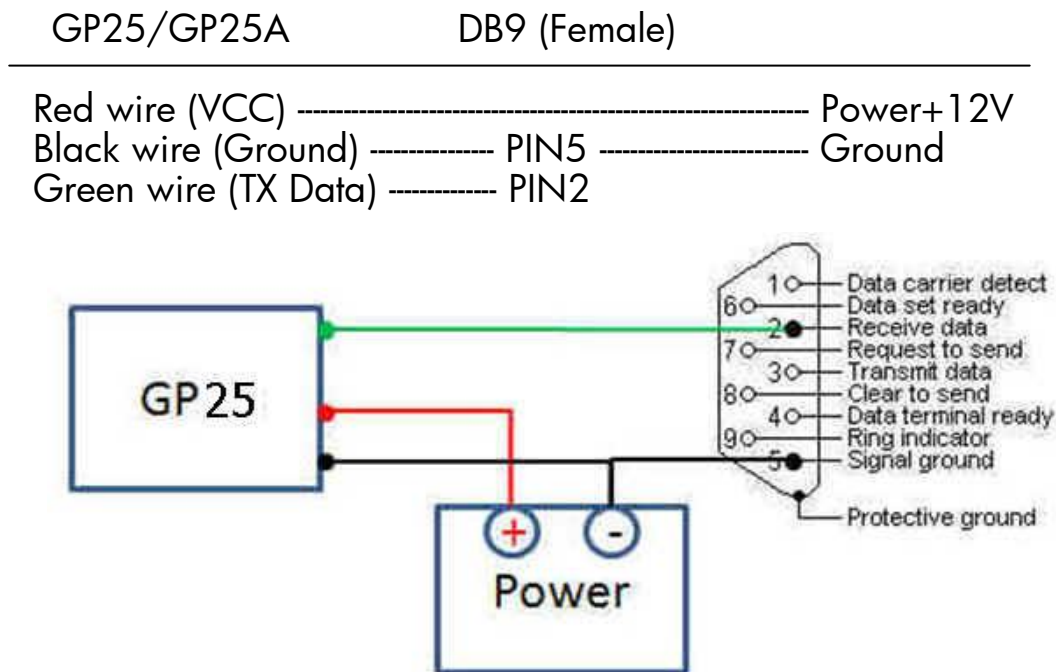

Note: There are two black wires, please select the right one to connect to Ground.

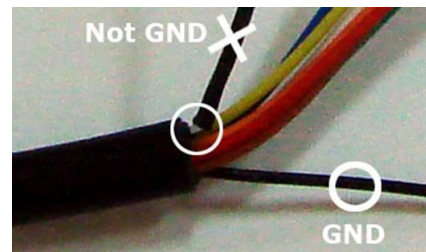

3. Use HyperTerminal program

Step1. Open HyperTerminal program.
(Start\ Programs\ Accessories\ Communications\ HyperTerminal)

Step2. Enter a name and then click [OK].

Step3. Select the COM port and then click [OK].



Step4. Set the values as below and then click [OK].

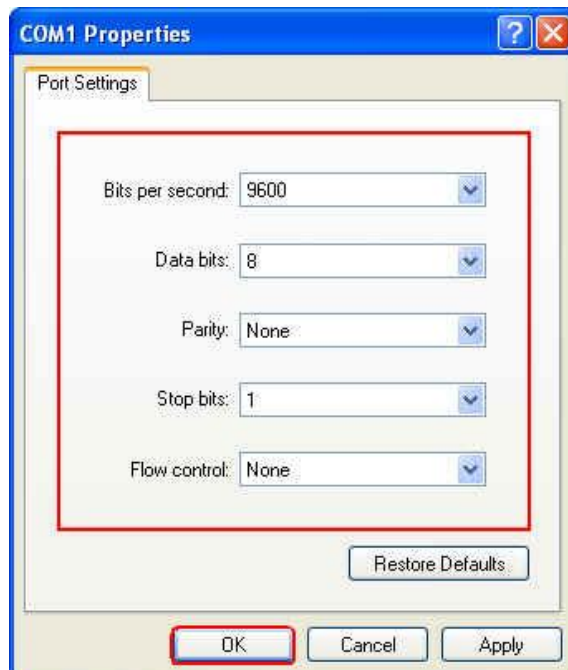

Step5. Read a tag on GP25/GP25A. The unit will sound a beep and the data output will show in the window.

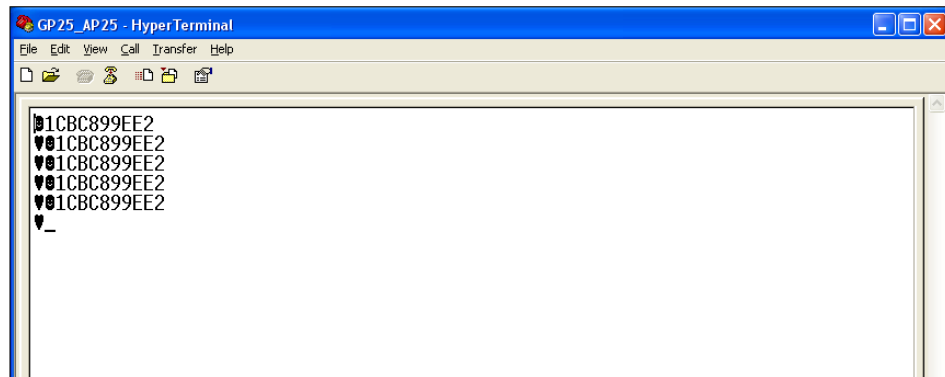

Data structure - Serial ASCII(RS232) Baud Rate: 9600, No parity, 8 data bits, 1 stop bit

STX (02 HEX)	DATA (10 HEX CHARACTERS)	CR	LF	ETX (03HEX)
--------------	--------------------------	----	----	-------------

How to Connect GP25/GP25A with Controller

1. RS232 interface

Refer to "2. Connect GP25/GP25A with computer via RS232" on page 1.

2. Wiegand interface

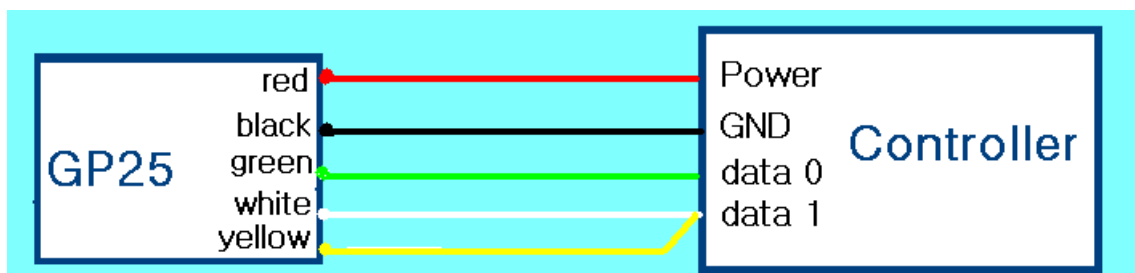

Data structure - Wiegand: (Format-26 Bits)

0	1	2	3	4	5	6	7	8	9	1	1	1	1	1	1	1	1	2	2	2	2	2	2	
									0	1	2	3	4	5	6	7	8	9	0	1	2	3	4	5
P	S	S	S	S	S	S	S	S	C	C	C	C	C	C	C	C	C	C	C	C	C	C	C	P
P	E	E	E	E	E	E	E	E	E	E	E	E												
SUMMED FOR EVEN PARITY (E)											SUMMED FOR ODD PARITY (O)													

3. Magstripe interface (ABA Track2)

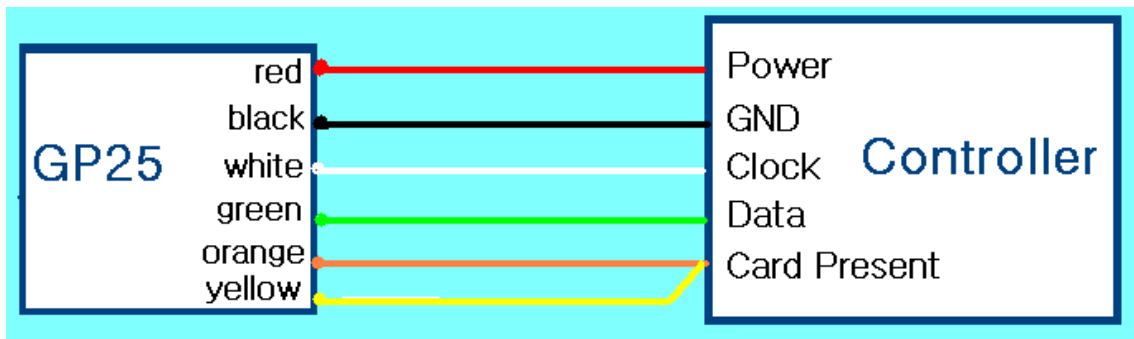

Data structure - Speed: Simulated to 40 IPS (Inch per Second)

10 LEADING ZEROS	SS	DATA (14 DIGITS)	ES	LRC	10 TRILING ZEROS
------------------	----	------------------	----	-----	------------------

How to Mount GP25/GP25A

There are two sets of accessory screws.



We suggest using "A" set when GP25/GP25A is installed on the woody or soft material.

Example



We suggest using "B" set when GP25/GP25A is installed on the concrete or hard material. (Please make two holes with the punch.)

Example

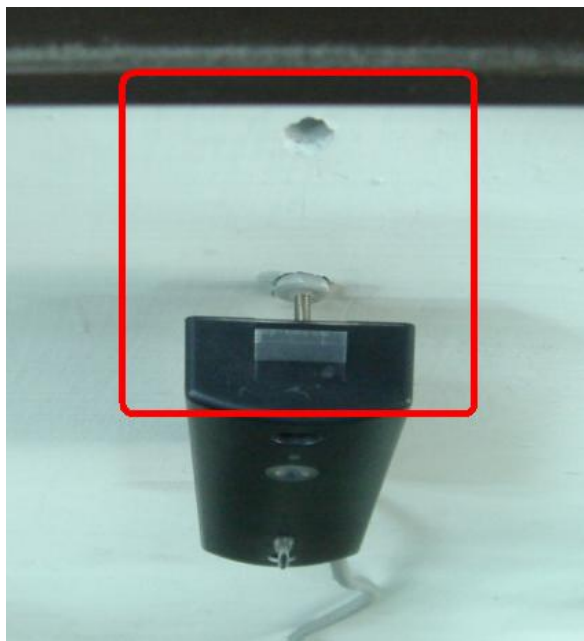

Dimensions

GP25/GP25A

Unit: mm

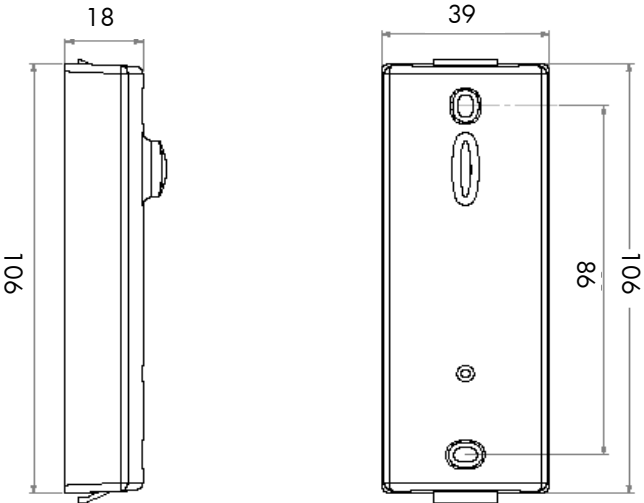

GP25 Outside Cover

GP25A Outside Cover

